

PROJECT	QUANTITY	ITEM NO
---------	----------	---------

FlexFusion™ combi oven

Gold Series

FGE 615 Electric
FGG 615 Gas
FlexiRack®



Henny Penny FlexFusion combi ovens combine different cooking methods into one piece of equipment with the flexibility to cook nearly everything on your menu.

The FlexFusion combi incorporates a powerful energy-efficient boilerless steam generation system that quickly adds the precise amount of moisture needed to maintain desired cooking conditions... all without the delimiting and maintenance of a boiler.

The Gold Series incorporates many high-end features, such as a 316 stainless steel interior, double-pane door glass, and WaveClean® self-cleaning system.

A simplified control interface offers humidity control, programmability and multi-step cooking. Core temperature probe and USB port are standard.

Removable tilt-resistant crosswise rails accept full-size steam table pans or FlexiRack pans and grids that offer additional capacity.

Four cooking modes:

- **Steaming**—Moist heat
86-266°F (30-130°C)
Low and high temperature steaming
- **Convection cooking**—Dry heat
86-572°F (30-300°C) electric
86-482°F (30-250°C) gas
- **Combination**—Dry + moist heat
86-482°F (30-250°C)
- **Rethermalizing**—Dry + moist heat
86-356°F (30-180°C)

Standard Features

- Simple controls with choice of function and digital display for:
 - Cook time
 - Humidity
 - Cabinet temperature
 - Core temperature
- ClimaSelect control maintains humidity level at 25% increments
- Create and store up to 50 custom multi-stage cooking programs with up to 6 sequential functions
- Probe cooking
- Temperature in °F or °C
- DynaSteam2 precision boilerless steam generation with built-in energy-saving heat transfer
- 6-level removable pan rack with tilt-resistant rails
- Crosswise pan racking for better ergonomics
- 5-speed auto-reverse fan for fast, even cooking throughout the cabinet
- Powerful high-efficiency motor uses up to 15% less energy
- Improved WaveClean® self-cleaning system uses 36% less water
- Retractable spray hose for quick, easy rinsing of interior
- Filterless grease extraction
- 316S11 stainless steel interior cabinet with coved corners
- 1 mm stainless steel exterior
- Full perimeter door seal
- Energy efficient double-pane glass
- Delayed start and preheat/cool down button
- USB port for convenient download of programs, diagnostic messages or HACCP data

Options, accessories*

- Stands and cabinets
- Stacking kit
- Chicken grids
- Alternate voltages
- Mobile oven racks, cart, rail insert

*See separate accessories data sheets for details

<input type="checkbox"/> APPROVED	<input type="checkbox"/> APPROVED AS NOTED	<input type="checkbox"/> RESUBMIT
AUTHORIZED SIGNATURE		DATE

HENNY PENNY
 Engineered to Last

PROJECT	ITEM NO
---------	---------

FlexFusion™ combi oven

Gold Series

FGE 615 Electric
FGG 615 Gas
FlexiRack®

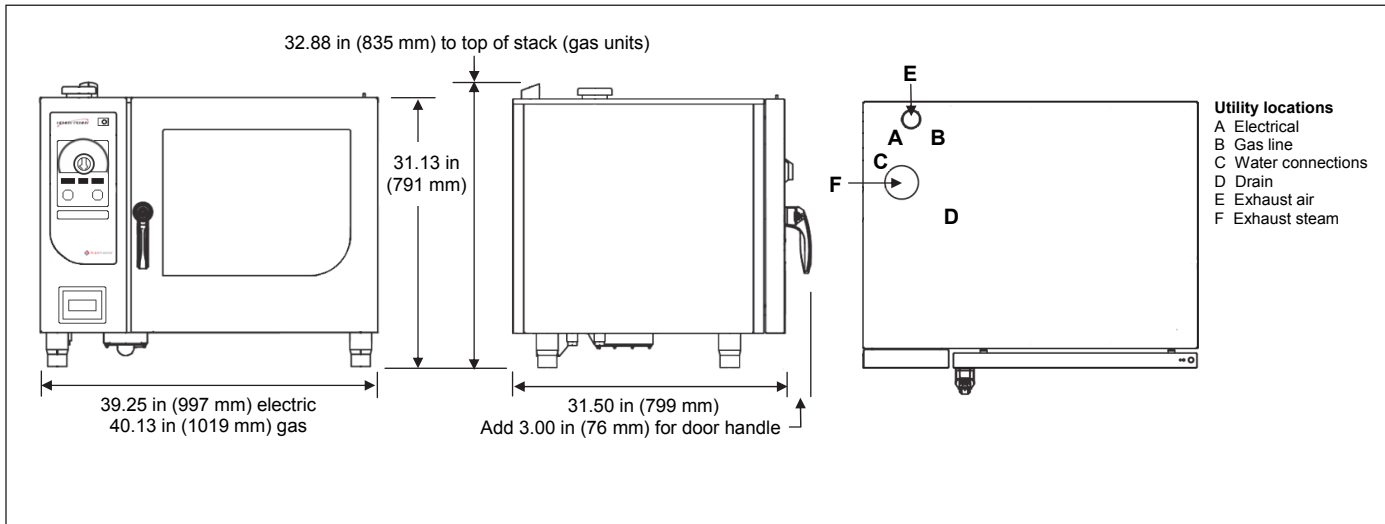

Dimensions

Height	31.13 in (791 mm) electric
	32.88 in (835 mm) gas
Width	39.25 in (997 mm) electric
	40.13 in (1019 mm) gas
Depth	31.50 in (799 mm)

Crated

Length	43 in (1080 mm)
Depth	38 in (960 mm)
Height	40 in (1020 mm)
Volume	38 ft ³ (1.1 m ³)
Weight	375 lb (170 kg)

Required clearances

Left	20 in (500 mm) service access
Right	2 in (50 mm) air flow
Back	2 in (50 mm) air flow, utilities
Front	28 in (700 mm) door open

Heat

Electric	Max temperature 572°F (300°C)
Gas	0.75 in gas line NPT external thread 37,500 BTU/hr or 11 kW/hr Max temperature 482°F (250°C)

Water

0.75 in standard cold water connection
0.75 in soft water connection
2.0 in (50 mm) drain

Capacity

- 6 full-size 2.5 in (65 mm) steam table pans crosswise
- 6 FlexiRack pans and grids
- 2 standard 6-chicken grids crosswise, 12 chickens per load
- 4 half-size FlexiRack 6-chicken grids, 2 per rail, 24 chickens per load

Bidding specifications

Provide Henny Penny FlexFusion Gold Series FGE 615 electric or FGG 615 gas combi oven, designed to cook with steaming/moist heat, convection/dry heat, or a combination of dry and moist heat, and holding up to 6 full-size steam table pans crosswise or 6 FlexiRack pans or grids on removable tilt-resistant rails.

Unit shall incorporate:

- Boilerless DynaSteam2 Technology with precise humidity generation and heat exchange
- ClimaSelect humidity control in 25% increments
- Variable speed, auto reverse fan that moves air in alternating directions for more even heating
- Automated WaveClean® self-cleaning system
- Seamless stainless steel cooking chamber, full-perimeter door seal and double-pane glass for energy efficiency
- Cabinet interior: 316S11 stainless steel
cabinet exterior: 1 mm stainless steel

Electrical

Volts	Phase	Hertz	kW	Amps	Wire
208	3	60	10.4	28.9	3+G
240	3	60	13.7	32.9	3+G
400	3	50/60	10.9	15.7	3NG

for gas units

120	1	60	0.8	3.9	1NG
230	1	50/60	0.8	2.0	1NG

Laboratory certifications



Continuing product improvement may subject specifications to change without notice.

24 Hour Technical Support:
Henny Penny Technical Service
800.417.8405
technicalservices@hennypenny.com

Henny Penny Corporation
PO Box 60 Eaton OH 45320 USA
+1 937 456.8400 800 417.8417
+1 937 456.8434 Fax 800 417.8434 Fax
www.hennypenny.com

HENNY PENNY
Engineered to Last